

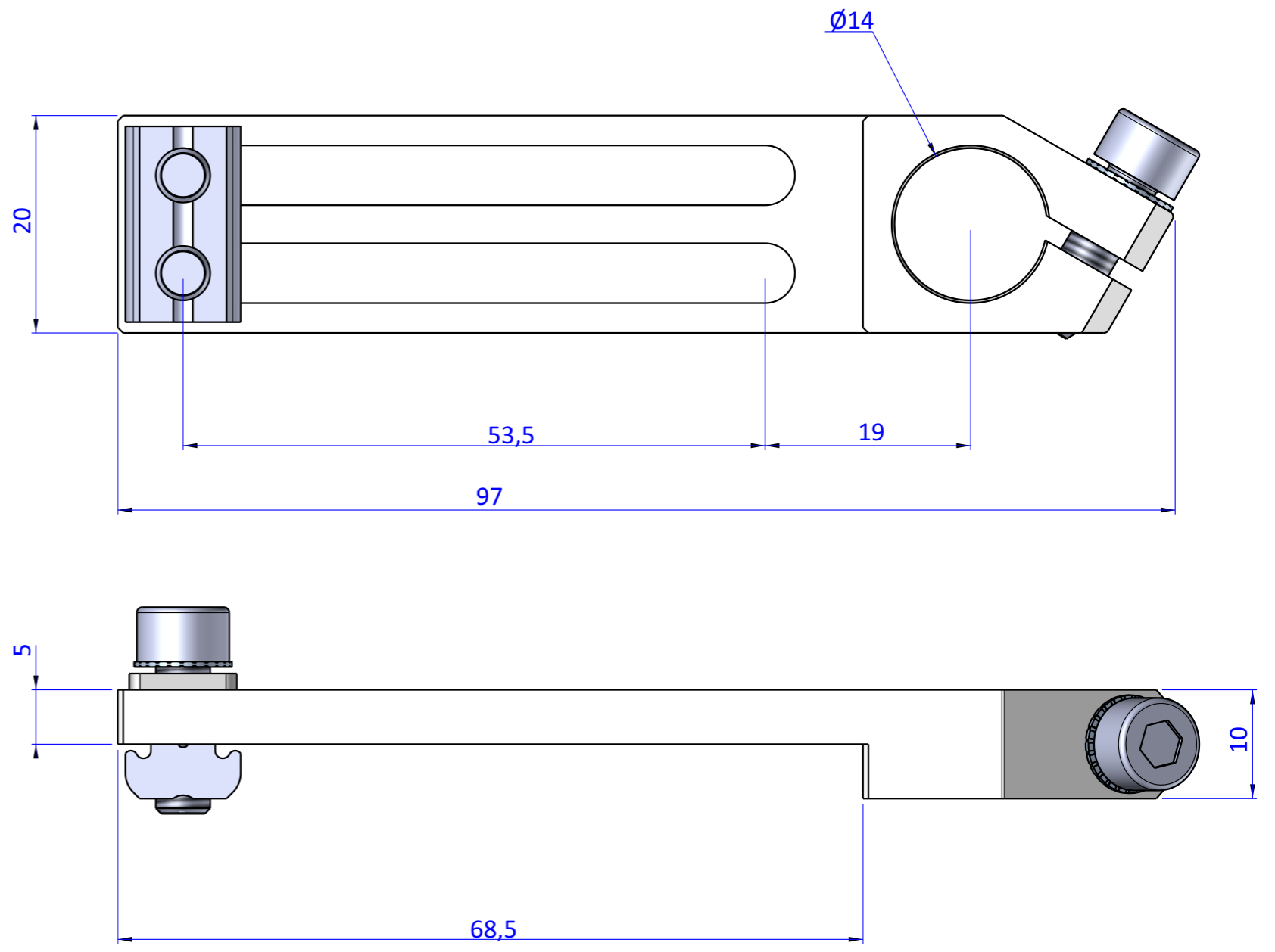

THE PROPERTY OF THE DRAWING IS ESTABLISHED BY LAW. IT IS FORBIDDEN TO PRODUCE OR SHOW IT TO THIRD PART. WITHOUT A WRITTEN AGREEMENT.

Item	Name	Q.ty
1	CA.GWP.5.9	1
2	CA.WSL.1450.U	1
3	R.05.09	1
4	R.5.SCH	2
5	V.TCE5x14	2

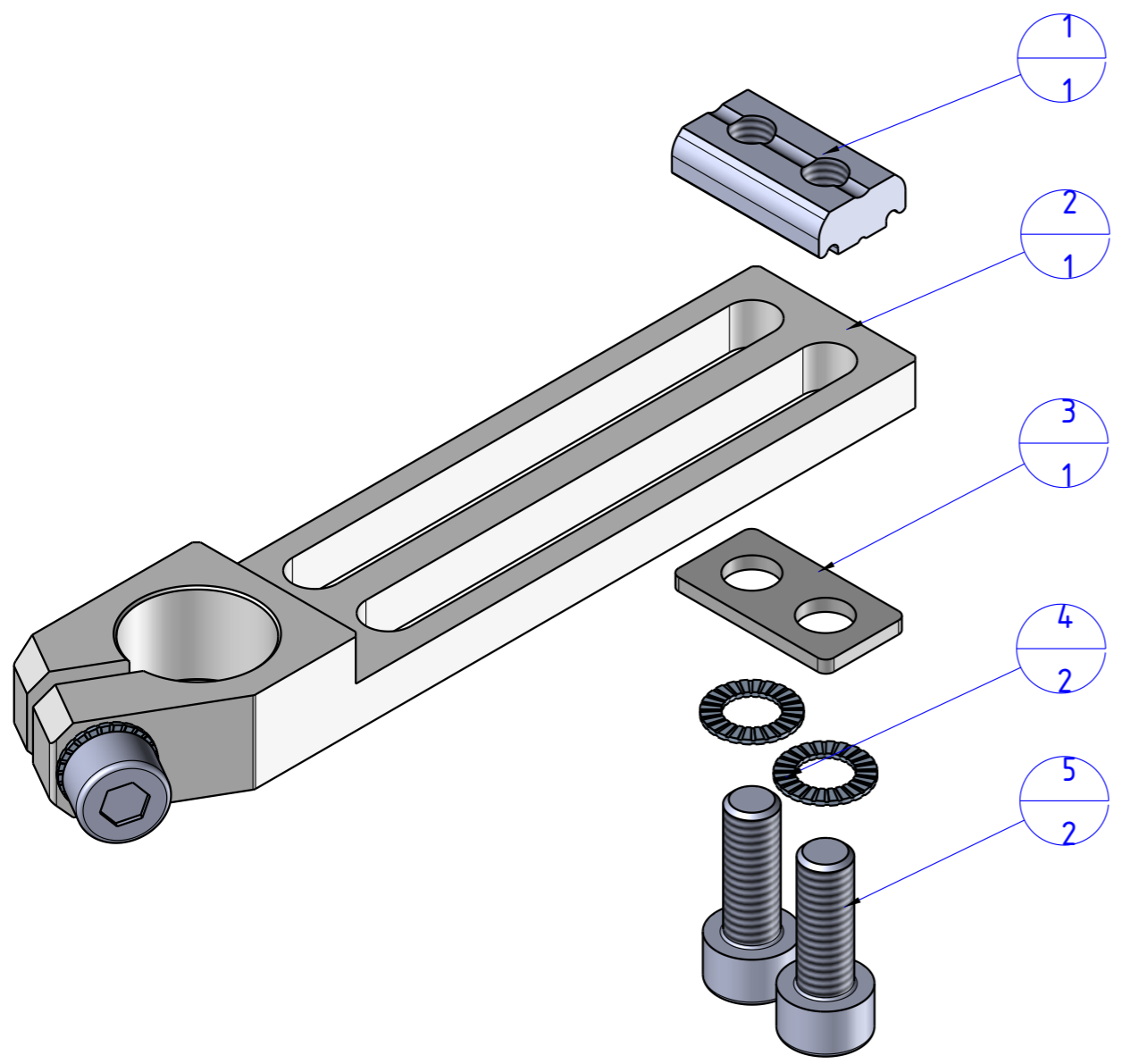

Format A3
UNI 936-76

 FPS FPSERVICES AUTOMATION		DESIGNED FROM		REVIEW
		FPS Automation		A
GENERAL TOLERANCE		DATE	WEIGHT	
UNI - ISO 2768		01/03/2021	0,016kg	
CLASSE f		DESCRIPTION	CODE	
		CA.WSL.1450.U.X	CA.WSL.1450.U.X	